



User Manual

English

APC Smart-UPS[®] SC

**420/620 VA
110/120/230 Vac**

**Tower
Uninterruptible Power Supply**

990-1853A, 12/2004

Introduction

The APC Uninterruptible Power Supply (UPS) is designed to prevent blackouts, brownouts, sags, and surges from reaching your equipment. The uninterruptible power supply (UPS) filters small utility line fluctuations and isolates your equipment from large disturbances by internally disconnecting from the utility line. The UPS provides continuous power from its internal battery until the utility line returns to safe levels or the battery is fully discharged.

1: INSTALLATION

The User Manual and Safety Guide are accessible on the supplied User Manuals CD and on the APC web site, www.apc.com.

Unpack

Attention: Read the safety instruction sheet before installation.

Inspect the UPS upon receipt. Notify the carrier and dealer if there is damage.

The packaging is recyclable; save it for reuse or dispose of it properly.

Check the package contents:

Attention: The UPS comes with battery disconnected.

- UPS
- UPS literature kit containing:
 - Product documentation, safety and warranty information
 - Smart-UPS® User Manuals CD
 - PowerChute® Business Edition CD
 - Serial communication cable
 - 230 V models: Two jumper cables

Position the UPS

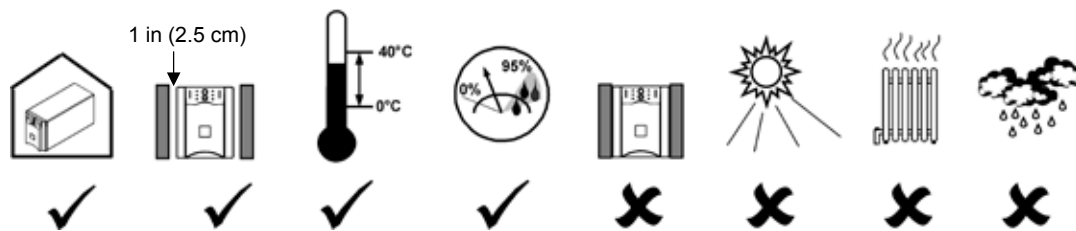

2: START UP

Connect the Battery

1

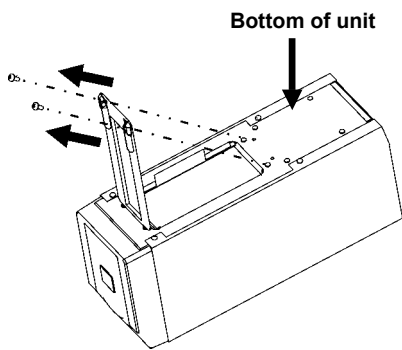

2

Connect black wire to battery. (Red wire is already connected.) Note: Small sparks at the point of battery connection are normal.

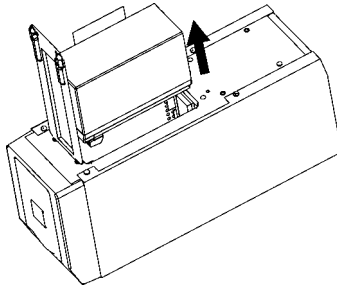

3

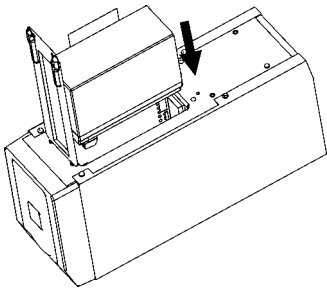

4

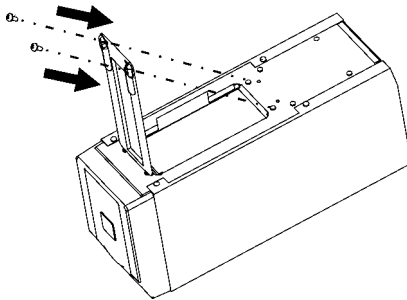

Connect Equipment to the UPS

Rear Panels

110/120 V:

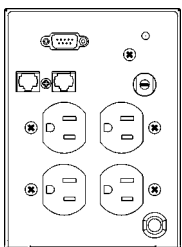

230 V:

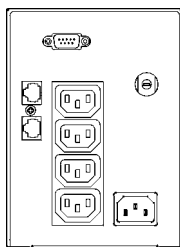

- *230 V models:* The top off-white outlet provides surge protection only. Equipment plugged into this 500 VA outlet should require surge protection, but should not require power during a utility power failure. The lower three outlets provide battery backup protection, as well as protection from surges.
- Note: A laser printer draws significantly more power than other types of equipment and may overload the UPS.

Connect the UPS to the Network (if Applicable)

Network Connectors

Serial Port

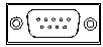

Telephone/Network Surge Suppression Ports



Use only interface kits approved by APC.

Use only the supplied cable to connect to the Serial Port. A standard serial interface cable is incompatible with the UPS.

The UPS features optional telephone/network surge suppression. Connect a single line telephone or a 10 Base-T/ 100 Base-Tx network cable into the RJ-45/RJ-11 telephone/network surge protection IN jack on the back of the UPS. Use a telephone cable (not supplied) or network cabling (not supplied) to connect the OUT jack to a fax modem or network port.

Start the UPS

1. Plug the UPS into a two-pole, three-wire, grounded receptacle only. Avoid using extension cords.

110/120 V models: The power cord is attached to the UPS. The input plug is a NEMA 5-15P.

230 V models: The power cord set is supplied in the UPS literature kit. **Attention: Upon utility power connection, the top outlet is immediately powered; the bottom three outlets are powered after the UPS performs the self-test.**

2. *110/120 V models:* Check the *site wiring fault* LED  located on the rear panel. It will be illuminated if the UPS is plugged into an improperly wired utility power outlet (see *Troubleshooting*).
3. Turn on all connected equipment. To use the UPS as a master *on/off* switch, be sure all connected equipment is on.
4. Press the button on the front panel to power the UPS.





Note: The battery charges fully during the first four hours of normal operation. Do not expect full battery run capability during this initial charge period. Refer to www.apc.com for battery runtimes.

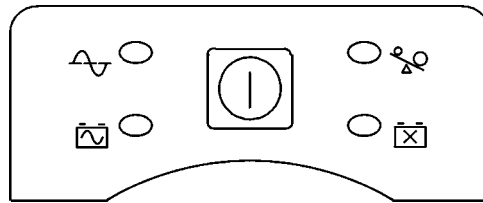

5. For optimal computer system protection, install PowerChute Business Edition management software to fully configure UPS shutdown and alarm settings.

3: OPERATION

Front Display Panel



INDICATOR	DESCRIPTION
Online 	The UPS is supplying utility power to the connected equipment.
On Battery 	The UPS is supplying battery power to the connected equipment.
Overload 	The connected loads are drawing more than the UPS power rating.
Replace Battery 	The battery must be replaced.

FEATURE	FUNCTION
Power Button 	Press this button to turn the UPS on or off. (Read on for additional capabilities.)
Self-Test	<p>Automatic: The UPS performs a self-test automatically when turned on, and every two weeks thereafter (by default). During the self-test, the UPS briefly operates the connected equipment on battery.</p> <p>Manual: Press and hold the  button for a few seconds to initiate the self-test.</p>
Cold Start	Supply battery power to the UPS and connected equipment in the absence of utility voltage (see <i>Troubleshooting</i>). Press the  button for one second and release. The UPS will beep briefly and go quiet. Press and hold the button again, but for approximately three seconds. The unit will emit a sustained beep. Release the button during this beep.

4: USER CONFIGURABLE ITEMS

NOTE: SETTINGS ARE ADJUSTED THROUGH POWERCHUTE BUSINESS EDITION SOFTWARE			
FUNCTION	FACTORY DEFAULT	USER SELECTABLE CHOICES	DESCRIPTION
Automatic Self-Test	Every 14 days (336 hours)	Every 7 days (168 hours), On Startup Only, No Self-Test	Set the interval at which the UPS will execute a self-test.
UPS ID	UPS_IDEN	Up to eight characters (alphanumeric)	Uniquely identify the UPS, (i.e. server name or location) for network management purposes.
Date of Last Battery Replacement	Manufacture Date	mm/dd/yy	Reset this date when you replace the battery module.
Minimum Capacity Before Return from Shutdown	0 percent	0, 15, 50, 90 percent	Specify the percentage to which batteries will be charged following a low-battery shutdown before powering connected equipment.
Voltage Sensitivity The UPS detects and reacts to line voltage distortions by transferring to battery operation to protect connected equipment.	High	High sensitivity, Medium sensitivity, Low sensitivity	Note: In situations of poor power quality, the UPS may frequently transfer to battery operation. If the connected equipment can operate normally under such conditions, reduce the sensitivity setting to conserve battery capacity and service life.
Alarm Delay After Line Fail	5 seconds	30 second delay, At low battery condition, No alarm	Set the delay to avoid alarms for minor power glitches.
Shutdown Delay	60 seconds	60, 180, 300, 600 seconds	Set the interval between the time when the UPS receives a shutdown command and the actual shutdown.
Low Battery Warning	2 minutes PowerChute Business Edition software provides automatic, unattended shutdown when approximately 2 minutes of battery operated runtime remains.	2, 5, 7, 10 minutes (Times are approximate.)	The UPS will beep when 2 minutes of battery runtime remains. Change the low battery warning interval setting to the time that the operating system or system software requires to safely shut down.

NOTE: SETTINGS ARE ADJUSTED THROUGH POWERCHUTE BUSINESS EDITION SOFTWARE			
FUNCTION	FACTORY DEFAULT	USER SELECTABLE CHOICES	DESCRIPTION
Synchronized Turn-on Delay	0 seconds	0, 60, 180, 300 seconds	Specify the time the UPS will wait after the return of utility power before turn-on (to avoid branch circuit overload).
High Transfer Point	<i>110/120 V model:</i> 127 Vac <i>230 V model:</i> 253 Vac	<i>110/120 V model:</i> 127, 130, 133, 136 Vac <i>230 V model:</i> 253, 257, 261, 265 Vac	Set the high transfer point higher to avoid unnecessary battery usage when the utility voltage is usually high and the connected equipment is specified to operate with input voltages this high.
Low Transfer Point	<i>110/120 V model:</i> 106 Vac <i>230 V model:</i> 208 Vac	<i>110/120 V model:</i> 97, 100, 103, 106 Vac <i>230 V model:</i> 196, 200, 204, 208 Vac	Set the low transfer point lower when the utility voltage is usually low and the connected equipment is specified to operate with input voltages this low.

5: STORAGE AND MAINTENANCE

Storage

Store the UPS covered in a cool, dry location, with the battery fully charged.

At -15 to +30 °C (+5 to +86 °F), charge the UPS battery every six months.

At +30 to +45 °C (+86 to +113 °F), charge the UPS battery every three months.

Battery Replacement

The UPS battery life differs based on usage and environment. Consider replacing the battery every three years.

This UPS has an easy to replace, hot-swappable battery. Replacement is a safe procedure, isolated from electrical hazards. You may leave the UPS and connected equipment on during the replacement procedure. See your dealer or contact APC (see *Contact Information*) for information on replacement batteries.

Note: Upon battery disconnection, equipment is not protected from power outages.

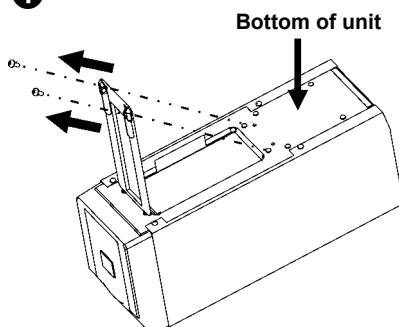

- 1**

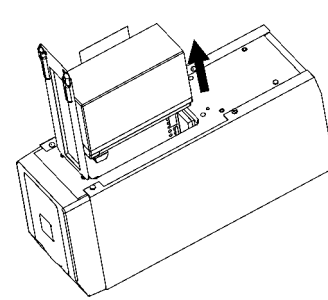
- 2** Disconnect the battery wires.

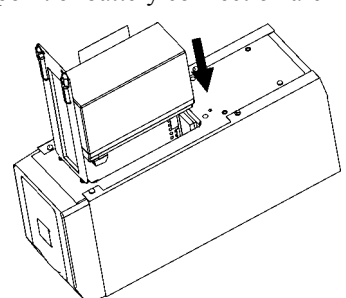
- 3** Connect the new battery by matching red and black wires and connectors. Note: Small sparks at the point of battery connection are normal.

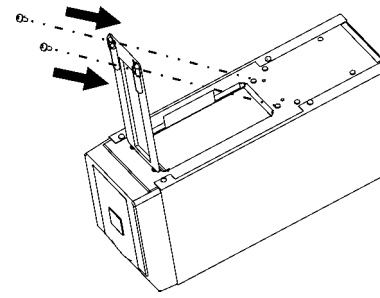

- 4**



  Be sure to deliver the spent battery to a recycling facility or ship it to APC in the replacement battery packing material.

6: TROUBLESHOOTING, SHIPPING, AND SERVICE

Use the chart below to solve minor UPS installation and operation problems. Refer to www.apc.com with complex UPS problems, and for battery runtime charts.

PROBLEM AND/OR POSSIBLE CAUSE	SOLUTION
UPS WILL NOT TURN ON	
UPS not connected to utility power supply.	Check that the power cord from the UPS to the utility power supply is securely connected at both ends.
Battery not connected properly.	Check that battery is properly connected.
Very low or no utility voltage.	Check the utility power supply to the UPS by plugging in a table lamp. If the light is very dim, have the utility voltage checked.
UPS WILL NOT TURN OFF	
Internal UPS fault.	Do not attempt to use the UPS. Unplug the UPS, unplug the battery, and have it serviced immediately.
UPS BEEPS OCCASIONALLY	
Normal operating UPS beeps when running on battery.	None. The UPS is protecting the connected equipment from occasional utility power irregularities. Press the  button to silence this alarm.
UPS IS NOT PROVIDING EXPECTED BACKUP TIME	
The UPS battery is weak due to a recent outage or is near the end of the service life.	Charge the battery. Batteries require recharging after extended outages, and wear faster when frequently put into service or when operated at elevated temperatures. If the battery is near the end of the service life, consider replacing even if the <i>replace battery</i> LED is not yet illuminated.
ONLINE AND OVERLOAD LEDS ARE FLASHING ALTERNATELY	
The UPS was shut down through PowerChute Business Edition software.	None. The UPS will restart when utility power returns.
ALL LEDS ARE FLASHING OR ONLINE AND ON-BATTERY LEDS ARE FLASHING	
Internal UPS fault. The UPS has shut down.	Do not attempt to use the UPS. Turn off the UPS, disconnect the battery, and have it serviced immediately.
ALL LEDS ARE OFF AND THE UPS IS PLUGGED INTO A WALL OUTLET	
The UPS is shut down or the battery is discharged from an extended outage.	None. The UPS will return to normal operation when the power is restored and the battery has a sufficient charge.

PROBLEM AND/OR POSSIBLE CAUSE	SOLUTION
THE OVERLOAD LED IS ILLUMINATED AND THE UPS EMITS A SUSTAINED ALARM TONE	
The UPS is overloaded. The connected equipment is drawing more VA than the UPS can sustain.	<p>The connected equipment exceeds the specified "maximum load."</p> <p>The alarm remains on until the overload is removed. Disconnect nonessential equipment from the UPS to eliminate the overload.</p> <p>The UPS continues to supply power as long as it is online and the circuit breaker does not trip; the UPS will not provide power from batteries in the event of a utility voltage interruption.</p> <p>If a continuous overload occurs while the UPS is on battery, the unit turns off output in order to protect the UPS from possible damage.</p>
THE REPLACE BATTERY LED IS ILLUMINATED	
Weak battery.	Allow the battery to recharge for 24 hours. Then, perform a self-test. If the problem persists after recharging, replace the battery.
Failure of a battery self-test.	The UPS emits short beeps for one minute and the <i>replace battery</i> LED illuminates. The UPS repeats the alarm every five hours. Perform the self-test procedure after the battery has charged for 24 hours to confirm the <i>replace battery</i> condition. The alarm stops and the LED clears if the battery passes the self-test.
THE SITE WIRING FAULT LED ON THE REAR PANEL IS ILLUMINATED (110/120 V MODEL ONLY)	
The UPS is plugged into an improperly wired utility power outlet.	<p>Wiring faults detected include missing ground, hot-neutral polarity reversal, and overloaded neutral circuit.</p> <p>Contact a qualified electrician to correct the building wiring.</p>
THE INPUT CIRCUIT BREAKER HAS TRIPPED	
The UPS is overloaded. The plunger on the circuit breaker has popped out.	Reduce the load on the UPS by unplugging equipment. Press in the plunger on the circuit breaker.
UPS OPERATES ON BATTERY ALTHOUGH UTILITY VOLTAGE EXISTS	
The UPS input circuit breaker has tripped.	To reduce the load on the UPS, unplug equipment and press in the plunger on the circuit breaker.
The line voltage is very high, low or distorted.	Move the UPS to a different outlet on a different circuit, as inexpensive fuel powered generators may distort the voltage. If acceptable to the connected equipment, reduce the UPS sensitivity (see <i>User Configurable Items</i>).
ONLINE LED	
There is no illumination.	The UPS is running on battery, or it must be turned on.
The LED is blinking.	The UPS is running an internal self-test.

Shipping and Service

Prepare the UPS for shipping:

Shutdown and disconnect any equipment attached to the UPS. Shut down the UPS, and disconnect the UPS from the utility power outlet. Disconnect the battery.

If the UPS requires service do not return it to the dealer. Follow these steps:

1. Review the problems discussed in *Troubleshooting* to eliminate common problems.
2. If the problem persists, contact APC Customer Service through the APC web site, www.apc.com/support.
 - Note the model number of the UPS, the serial number, and the date purchased. If you call APC Customer Service, a technician will ask you to describe the problem and attempt to solve it over the phone. If this is not possible, the technician will issue a Returned Material Authorization Number (RMA#).
 - If the UPS is under warranty, repairs are free.
3. Pack the UPS in its original packaging. If this is not available, refer to www.apc.com/support for information about obtaining a new set.
 - Pack the UPS properly to avoid damage in transit. Never use Styrofoam beads for packaging. Damage sustained in transit is not covered under warranty.
 - **Always DISCONNECT THE BATTERY before shipping in compliance with U.S. Department of Transportation (DOT), and IATA regulations.** The battery module(s) may remain in the UPS; it does not have to be removed.
4. Mark the RMA# on the outside of the package.
5. Return the UPS by insured, prepaid carrier to the address given to you by Customer Service.

Contact Information

U.S. Customers - Refer to www.apc.com/support.

International Customers - Refer to www.apc.com, select the appropriate country from the country selection field, and select the *Support* tab at the top of the web page.

7: REGULATORY AND WARRANTY INFORMATION

110/120 V models

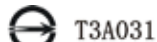

警告使用者：
這是甲類的資訊產品，在居住的
環境中使用時，可能會造成射頻
干擾，在這種情況下，使用者會
被要求採取某些適當的對策。

This equipment has been tested and found to comply with the limits for a Class A digital device, pursuant to part 15 of the FCC Rules. These limits are designed to provide reasonable protection against harmful interference when the equipment is operated in a commercial environment. This equipment generates, uses, and can radiate radio frequency energy and, if not installed and used in accordance with the instruction manual, may cause harmful interference to radio communications. Operation of this equipment in a residential area is likely to cause harmful interference in which case the user will be required to correct the interference at his/her own expense.

Shielded signal cables must be used with this product to ensure compliance with the Class A FCC limits.

230 V models



This is a Class A product. In a domestic environment this product may cause radio interference, in which case the user may be required to take corrective actions.

EC Declaration of Conformity

Date of product declaration **2004**

We, the undersigned, declare under our sole responsibility that the equipment specified below conforms to the following standards and directives:

Standards to Which Conformity Declared:

EN62040-1-1; EN55022; EN55024;
EN61000-3-2, 3-3, 4-2, 4-4, 4-5, 4-6, 4-8, 4-11;
EN60950; IEC60950-1; EN50091-2

Application of Council Directives:

73/23/EEC; 93/68/EEC; 89/336/EEC

Type of Equipment:

PowerSupply

Model Numbers:

SC4201, SC6201

Importer's Name and Address:

American Power Conversion
Ballybritt Business Park
Galway, Ireland

Manufacturer's Name and Address:

American Power Conversion (A.P.C.)
Ballybritt Business Park,
Galway, Ireland

American Power Conversion
132 Fairgrounds Rd.
West Kingston, RI 02892 USA

APC (Suzhou) UPS Co., Ltd
339 Suhong Zhong Lu
Suzhou Industrial Park
Suzhou Jiangsu 2215021
P. R. China

APC India Pvt. Ltd.
187/3, 188/3, Jigani Industrial Area
Bangalore, 562106
Karnataka
India

American Power Conversion
Lot 3, Block 14, Phase 3
PEZA, Rosario, Cavite
Philippines

American Power Conversion
2nd Street
PEZA, Cavite Economic Zone
Rosario, Cavite
Philippines

American Power Conversion
Lot 10, Block 16, Phase 4
PEZA, Rosario, Cavite
Philippines

APC Brasil LTDA,
Al. Xingu, 850
Barueri
Alphaville/Sao Paulo
06455-030
Brazil

Place: Ray S. Ballard Managing Director, Europe
Galway, Ireland

5 Jan 04

Place: Richard J. Everett Sr. Regulatory Compliance Engineer
N. Billerica, MA
USA

5 Jan 04

Limited Warranty

American Power Conversion (APC) warrants its products to be free from defects in materials and workmanship for a period of two years from the date of purchase. Its obligation under this warranty is limited to repairing or replacing, at its own sole option, any such defective products. To obtain service under warranty you must obtain a Returned Material Authorization (RMA) number from customer support. Products must be returned with transportation charges prepaid and must be accompanied by a brief description of the problem encountered and proof of date and place of purchase. This warranty does not apply to equipment that has been damaged by accident, negligence, or misapplication or has been altered or modified in any way. This warranty applies only to the original purchaser who must have properly registered the product within 10 days of purchase.

EXCEPT AS PROVIDED HEREIN, AMERICAN POWER CONVERSION MAKES NO WARRANTIES, EXPRESSED OR IMPLIED, INCLUDING WARRANTIES OF MERCHANTABILITY AND FITNESS FOR A PARTICULAR PURPOSE. Some states do not permit limitation or exclusion of implied warranties; therefore, the aforesaid limitation(s) or exclusion(s) may not apply to the purchaser.

EXCEPT AS PROVIDED ABOVE, IN NO EVENT WILL APC BE LIABLE FOR DIRECT, INDIRECT, SPECIAL, INCIDENTAL, OR CONSEQUENTIAL DAMAGES ARISING OUT OF THE USE OF THIS PRODUCT, EVEN IF ADVISED OF THE POSSIBILITY OF SUCH DAMAGE. Specifically, APC is not liable for any costs, such as lost profits or revenue, loss of equipment, loss of use of equipment, loss of software, loss of data, costs of substitutes, claims by third parties, or otherwise.

Entire contents copyright 2004 by American Power Conversion Corporation. All rights reserved. Reproduction in whole or in part without permission is prohibited.

APC, the APC logo, Smart-UPS, and PowerChute are registered trademarks of American Power Conversion Corporation. All other trademarks are the property of their respective owners.