

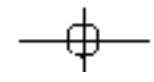

PowerSure™ Personal XT

450, 700, 1250 VA
230V

USER MANUAL
English / Deutsch / Français /
Italiano / Español



IMPORTANT SAFETY INSTRUCTIONS

SAVE THESE INSTRUCTIONS

This manual contains important safety instructions that should be followed during the installation and maintenance of the UPS and its batteries. Please read this manual thoroughly before attempting to install or operate this UPS.

This equipment can be installed and operated by individuals without previous training.

1. PowerWare Personal XT models are available for 230VAC supply voltages and loads. Please verify that this model matches your AC mains/ load voltage requirements.
2. This equipment is designed for Commercial/Industrial use only. Liebert Corporation neither recommends nor knowingly sells this product for use in critical life support applications.
3. The PowerWare Personal XT 230VAC models are not supplied with an input power lead for connection to the mains supply. Use the input mains power lead from your data processing equipment to connect the UPS to the mains supply. The UPS is supplied with two output power leads with insulated connectors to connect from the UPS output to your equipment. Additional input/output leads can be obtained from your dealer.
Also provided is a Liebert special interconnection cable for connection to DB9 connector on the rear of the UPS for use with Liebert's SiteNet MultiLink2 software (see user manual for details) **DO NOT USE FOR OTHER APPLICATIONS.** Store in safe place if not required at this time.
4. This UPS must be earthed at all times during operation. Connect only to a mains supply socket outlet with an earth connection. A means of disconnection of the mains supply should be within 2 metres of the UPS.
5. **WARNING:** Output receptacles on the UPS are electrically live if the UPS is switched ON, even if the UPS is not plugged in to a mains supply. The On/Off button on the UPS does not electrically isolate the internal parts. To isolate the UPS, switch OFF the UPS first, then unplug it from the mains.
 - To reduce the risk of electric shock, do not remove the cover, as it has no user-serviceable parts inside. Some components are live, even when AC power is disconnected. For service, contact a qualified technician.
 - To reduce the risk of fire, use the proper rating when replacing the fuse.
 - To prevent the risk of fire or electric shock, install the UPS in a temperature and humidity controlled room, free of conductive contaminants.
6. Your total load earth leakage current must not exceed 3.6 mill-ampere. Most data processing equipment meets this requirement if you use no more than 2 pieces of equipment. For further advice contact your dealer.
7. The UPS relies on your building wiring overcurrent protection, which must be rated between 10-20 amperes.
8. When using the communication features on the UPS, ensure the cabling connected to the DB9 communication port or the network connection are kept separated by 25mm from the power leads to the UPS input and output.

These units bear TUV GS mark, CE mark and comply with the following standards (limits value class B):

EN 60601 (1998.8),
EN 60601-1 (1994.4),
EMVRF: EN550222 class B
EMS: IEC 1000-4-2 (ESD) Level 3
IEC 1000-4-3 (RF) Level 3
IEC 1000-4-4 (EFT) Level 3
IEC 1000-4-6 (Lightning surge) Level 3

CAUTION:

Although your UPS has been designed and manufactured to ensure personal safety, improper use can result in electrical shock or fire. To insure safety, please observe the following rules:

- Turn off and unplug your UPS before cleaning. Do not use liquid or aerosol cleaners. A dry cloth is recommended to remove dust from the surface of your UPS.
- Do not install or operate your UPS in or near water.
- Do not place UPS on an unstable cart, stand, or table.
- Do not place UPS under direct sunlight or close to heat emitting sources.
- Do not place UPS power cord in any area where it may get damaged by heavy objects.
- Follow all warnings and instructions marked on the UPS. Do not attempt to service the UPS, as it has no user-serviceable parts inside. Refer all repairs to qualified service personnel.

ATTENTION:

Turn off and unplug your UPS from the outlet and contact qualified service personnel if:

- The power cord or plug is damaged.
- Liquid has been spilled on the UPS.
- The fuse blows frequently.
- The UPS does not operate even when user follows the operating instructions.

CONDITIONS OF USE:

Your UPS provides conditioned power to connected equipment. Maximum load must not exceed that shown on UPS rating label. If uncertain, consult your distributor or Liebert.

Placing magnetic storage media on top of the UPS may result in data corruption.

INTRODUCTION & SYSTEM DESCRIPTION

Congratulations on your choice of the Liebert PowerSure Personal XT Uninterruptible Power System (UPS). It provides conditioned power to microcomputers and other sensitive electronic equipment.

MAJOR COMPONENTS

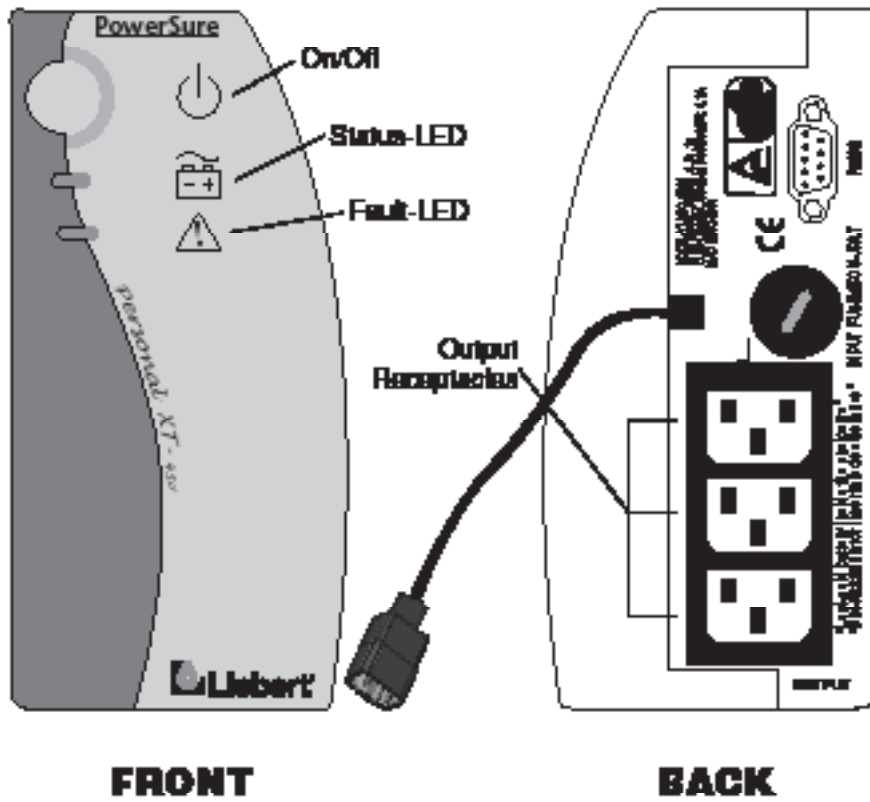

GENERAL INSTALLATION

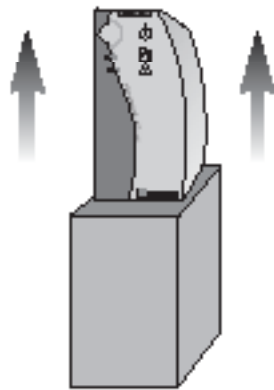

Remove from Box

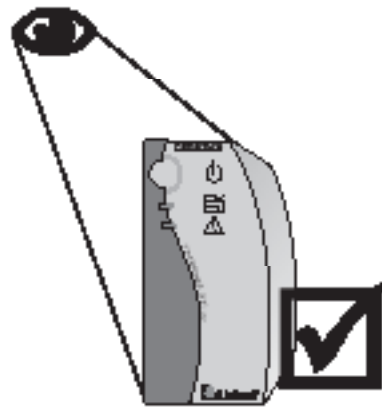

Check for Damage

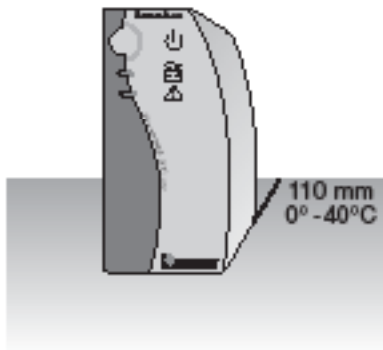

**Remove Plug from Units
and replace in UPS**

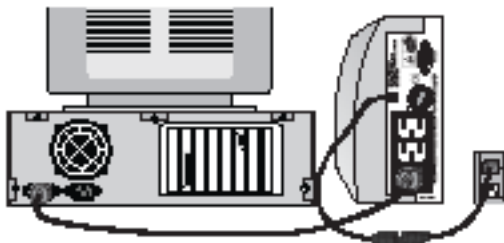

Plug Unit(s) into UPS

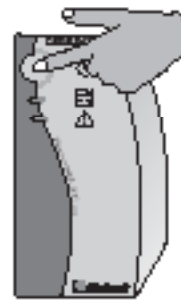

Press ON Button

NORMAL MODE OPERATION

1. Inspect the packaging carton and its contents for damage. Please inform the transport agency immediately should you find signs of damage. Please keep the packaging in a safe for future use.
2. Plug the UPS into a wall outlet (see figure 1). Let the UPS charge the battery for at least 2 hours. You may use the UPS while the battery charges, but the UPS backup time will be reduced until the battery is fully charged. It will take up to 8 hours to charge the fully discharged battery.
3. To start up the UPS, press the On/Off switch. When the UPS starts, it will beep and both LEDs of the front panel will light up for 2 seconds. The green light up continuously. This indicates normal operation.

Note:

If the UPS continues to beep, or the green light is not alight even when power is available, please see the chapter Troubleshooting for more information.

4. Switch off the equipment you want to protect, and connect it to the outlets of the UPS.
5. Switch on the protected equipment, one piece per line.



BATTERY MODE OPERATION

Battery mode occurs in event of extreme input mains conditions or a complete mains failure. During Battery mode the Mains / Battery LED (green) will flash every 4 seconds and an alarm will sound every 4 seconds. This will change to a beep every second when the battery runs low (approximately 2 minutes remaining).

WARNING: Turning off the UPS while in Battery mode will result in loss of output power.

LED & ALARMS

The front panel LEDs and audio beeps indicate the UPS status.

| Switch and LEDs | Symbol | Function |
|--------------------|---|---|
| On/off |  | Turn the UPS system on and off. |
| Status-LED (green) |  | <ol style="list-style-type: none"> 1. Steady: Input power is acceptable; the UPS is in normal mode (online). 2. Blinking: Input power is out of tolerance; the UPS is battery mode. 3. Off: No input power or the battery is exhausted or the UPS is switched off. |
| Fault-LED (red) |  | <ol style="list-style-type: none"> 1. Blinking: The UPS is overloaded or has failed at battery test. 2. Steady: UPS fault. |

| Switch and LEDs | Function |
|------------------------------|---|
| Beep continuously for 2 sec. | Starting up the UPS. |
| 1 beep every 4 sec. | Power failure: UPS is battery mode. |
| 1 beep every sec. | Battery low: UPS is in battery mode, batteries are nearly exhausted, and UPS will be shut down. |
| 1 beep every 2 sec. | Battery weak: UPS is normal mode (online), battery is not fully charged, backup time during power failure shorter than nominal value. |
| 3 beep every 2 sec. | Battery replacement: battery needs to be replaced. |
| 2 beep every 2 sec. | Charger fault: UPS cannot recharge the battery. See chapter Troubleshooting for more information. |
| 1 beep every half sec. | Overload. See chapter Troubleshooting for more information. |
| Continuous | Fault: please contact your dealer. |

TROUBLESHOOTING

If the UPS fails to operate properly, turn off the unit and repeat the steps in the installation section of this manual. If the problem persists, refer to the chart below:

| PROBLEM | POSSIBLE CAUSE | REMEDY |
|---|--|---|
| No indication, no beep even UPS is connected to main power supply | No input voltage Fuse has blown out | Check building wall outlet and main cable by connecting another device with cable to this wall outlet Replace fuse by fuse with same rating |
| Green LED blinks, red LED off, 1 beep every 4 sec. | Main power failure UPS input power cable not plugged in Power cord defective | Wait until main power resumes Make sure the power cord is connected Please contact your dealer |
| Green LED blinks, red LED off, 1 beep every sec. | very low battery voltage | Plug the UPS into a working wall outlet for at least 8 hours to recharge the batteries. If the problem still remains, the UPS will not operate during power failure, or it will turn off immediately. In this case, contact your dealer |
| Green LED lights up, red LED blinks, 2 beeps every 2 sec. | Battery cannot be charged | Please contact your dealer |
| Green LED lights up, red LED blinks, 1 beep every half sec. | The power acquired from the equipments is too high | Remove equipment until the UPS stops beeping |
| Green LED off, red LED lights up, continuous beeps | Output short circuit Overload exceeds 120% UPS lock | Remove all off the equipments and contact your dealer Reduce the load Contact your dealer |

COMMUNICATIONS

You can use MultiLink™ Software to allow your UPS to communicate to your computer via your DB-9 communications port. A MultiLink Software CD is included in the box, or you can download it from our web site at www.abbot.com.

The PowerSure™ Personal XT UPS contains a standard DB-9 receptacle located on the rear of the UPS unit. Several signals are provided on this port and are assigned as follows:

| PIN | ASSIGNMENT DESCRIPTION |
|-----|---|
| 1 | Low Battery (open collector) |
| 2 | No connection |
| 3 | No connection |
| 4 | Remote Shutdown (5-12V); on battery operation |
| 5 | Common |
| 6 | Remote Shutdown (short to pin5); any mode operation |
| 7 | Low Battery (open emitter) |
| 8 | AC Fail (open emitter) |
| 9 | AC Fail (open collector) |

PIN Assignment



The DB-9 communication port allows:

- the status of UPS to be monitored,
- data to be backed up,
- computer to be switched off

MAINTENANCE

The PowerSure Personal XT UPS requires very little maintenance. The batteries are valve regulated, nonspillable, lead acid, and require that they be kept charged to obtain their designed life. When connected to the mains supply, the battery is continuously charged.

When storing the UPS for any length of time, it is recommended to plug in the UPS for at least 24 hours every four to six months to ensure full recharge of the batteries.

Battery disposal - When the battery life is expended (see alarm indications), dispose of the discarded batteries in accordance with local environmental laws.

8

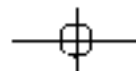

| 230V SPECIFICATIONS | | | |
|------------------------------------|---|------------------|------------------|
| ELECTRICAL SPECIFICATION | | | |
| Model Number | PSPKT468-220 | PSPKT700-230 | PSPKT1268-220 |
| INPUT | | | |
| Voltage | 230 VAC (187 - 262 VAC) | | |
| Frequency | 50 Hz \pm 4Hz; 60 Hz \pm 4Hz | | |
| Amperage (maximum) | 2.6 A | 4.8 A | 7.0 A |
| Phase | 12 ϕ 2W, Ground | | |
| OUTPUT | | | |
| Power rating | 468 VA - 270 W | 700 VA - 420 W | 1260 VA - 780 W |
| Voltage | 230 VAC \pm 1% | | |
| Frequency | 50 Hz \pm 1Hz; 60 Hz \pm 1Hz | | |
| Wave form | STEP | | |
| Overload protection | Line mode \geq 105%, \leq 130% load, 3 minutes to fault | | |
| | Line mode $>$ 130% load, 7s to fault | | |
| | Battery mode \geq 105%, \leq 120% load, 20s to shutdown | | |
| | Battery mode $>$ 120% load, 6s to shutdown | | |
| BATTERY PARAMETERS | | | |
| Model Number | PSPKT468-220 | PSPKT700-230 | PSPKT1268-220 |
| Type | Valve-regulated, nonspillable, lead acid | | |
| Quantity x Voltage x Rating | (1) x 12V x 7 Ah | (1) x 12V x 9 Ah | (2) x 12V x 7 Ah |
| Approved Battery Manufacturers: | GSE, Panasonic, BB Battery and Yuesen | | |
| Transfer Time | 2 - 8 ms typical | | |
| Operating Back-up time | $>$ 18 minutes | | |
| Recharge time | Rtr up to 80% | | |
| DIMENSION AND WEIGHTS | | | |
| Dimensions w/feet (mm) | 30"173,5"233 | 31"175,5"233 | 42"238"233 |
| Net Weight, Kg | 3.6 | 3.8 | 8.6 |
| Gross Weight, Kg | 4.6 | 4.8 | 7.9 |
| OPERATING ENVIRONMENT | | | |
| Operation temperature: 0°C to 40°C | | | |
| Storage temperature: -15°C to 40°C | | | |
| Operation humidity: 20% to 80% | | | |

LIMITED WARRANTY

Libert Corporation extends the following LIMITED WARRANTY to the purchaser and to its customer (collectively referred to as the "Purchaser"): the enclosed Uninterruptible Power Systems (UPS) and components are free from defects in materials and workmanship under normal use, service, and maintenance FOR A PERIOD OF TWO YEARS FROM THE DATE OF ORIGINAL PURCHASE from Libert or the Libert dealer or retailer. THE FOREGOING WARRANTY IS THE ONLY WARRANTY GIVEN AND NO OTHER WARRANTY IS PROVIDED, EXPRESS OR IMPLIED, INCLUDING WITHOUT LIMITATION, MERCHANTABILITY OR FITNESS FOR A PARTICULAR PURPOSE. Certain aspects of this warranty are not applicable to consumer products acquired by individuals and used for personal, family, or household purposes (as distinguished from industrial or other purposes). Local laws may not allow limitations on how long an implied warranty lasts, so the above limitations may not apply to you. This warranty gives you specific legal rights, and you may have other rights which vary according to local law.

Certain repairs or services are the responsibility of the Purchaser and the Purchaser is expected to pay for them. This warranty does not extend either to products with removed or altered serial numbers or to any losses or damages due to act of God or source external to the product, misuse, accident, abuse, neglect, negligence, unauthorized modification, alteration, or repair, use beyond rated capacity, or improper installation, maintenance, application or use, including, without limitation, use in a manner contrary to the accompanying instructions or applicable codes. **WARNING:** Warranty is void if the battery is allowed to discharge below the minimum battery cutoff point. To prevent such discharge DO NOT leave the unit power switch "ON" for more than two (2) days without AC power being supplied to the UPS. The battery must be recharged every four (4) to six (6) months when not in use.

If the UPS fails to conform with the above warranty within the two year warranty period, Libert will repair or replace the UPS, at Libert's option. Repairs or replacements are warranted for the remainder of the original warranty period. To make a warranty claim, purchaser should call a Libert Representative to obtain a Returned Goods Authorization number and shipping instructions. Return transportation costs to Libert are the responsibility of the Purchaser.

"LIFE SUPPORT" APPLICATIONS

Due to the diversity of applications and considerations to be applied in each case, Libert does not recommend or knowingly sell its products for such use.

The responsibility for risk assessment and management in applications where the malfunction or failure of the UPS could be reasonably expected to give rise to a risk of human life shall be the sole responsibility of the purchaser. Libert accepts no liability for consequential items in such applications.